

# Smart Body Analyzer

Weight & Fat Mass- Heart Rate - Air Quality - Daily Report  
Installation and Operating Instructions



# User Guide Copyright

---

This User Guide is protected by Intellectual Property laws and copyright. Any reproduction, modification, representation, and/or publication without Withings prior approval is strictly prohibited. You may print this User Guide for your personal use exclusively. For any questions, please contact Withings at: <https://support.withings.com/hc/en-us/requests/new>.

## Safety Instructions

---

By using your Smart Body Analyzer you expressly agree to the Withings Services Terms and Conditions available on our [website](#).

This product is not a medical device and should not be used to diagnose or treat any medical condition.

This product should not be used by people wearing a pacemaker or any other internal medical device

## Use and Storage

- Use the product at temperatures between 5°C and 35°C (41°F and 95°F) with a relative humidity between 30% and 80%.
- Product may be stored in a clean location between -10°C and 50°C (14°F and 122°F) when it is not in use, with a relative humidity between 10% and 90%.
- This product is not a toy. Do not allow children to play with it.
- This device is designed for indoor use only.
- Do not allow the device to come in contact with liquids.
- Do not use any detergents or cleaners to clean the scale. They may cause irreversible damage to the coating that protects the electrodes used to measure your fat mass and heart rate.

## Location

- Do not use your Smart Body Analyzer in a place that is too humid as it can affect the batteries.
- Make sure you use the carpet feet if you place your Smart Body Analyzer on a carpet.

## Personal Data

- Make sure you have read our privacy policy, which you can find on our [website](#).
- Make sure your Withings account password is secure enough to restrict access to your account. It should be at least eight-character long, have mixed case, and use a combination of alphanumeric and special characters.

- We recommend that you protect access to the Withings Health Mate app with an additional passcode and/or Touch ID. You can do so from the app by going to **Settings** in the app and activating **Touch ID and Passcode**.
- We recommend that you export your data on a regular basis to local storage on your home computer. You can do so from the Withings Health Mate [web interface](#) by clicking **Measurement table**, selecting the tab corresponding to the data you want to export and clicking **Download**.

Refer to “[Retrieving Your Data](#)” on page 21 to for more information about the data you can retrieve from your Smart Body Analyzer.

## Service and Maintenance

- Do not attempt to repair or modify your Smart Body Analyzer yourself. Service and maintenance not described in this User Guide should be performed by professional technicians.
- If you have any issues, feel free to contact customer service at: <https://support.withings.com/hc/en-us/requests/new>.

# Table of Contents

---

|   |    |
|---|----|
| User Guide Copyright .....                                  | 2  |
| Safety Instructions.....                                    | 2  |
| Use and Storage .....                                       | 2  |
| Location .....  | 2  |
| Personal Data .....   | 2  |
| Service and Maintenance.....                                | 3  |
| Minimum Requirements .....                                  | 6  |
| Internet Access.....  | 6  |
| Smartphone or Device .....                                  | 6  |
| OS Version .....  | 6  |
| Smart Body Analyzer Description.....                        | 7  |
| Overview.....   | 7  |
| Box Contents.....   | 7  |
| Product Description.....                                    | 8  |
| Scales Screens Description .....                            | 8  |
| Setting Up the Smart Body Analyzer .....                    | 9  |
| Installing the Withings Health Mate App.....                | 9  |
| Installing your Smart Body Analyzer.....                    | 10 |
| Customizing Your Smart Body Analyzer.....                   | 21 |
| Changing the Configuration of Your Smart Body Analyzer..... | 21 |
| Changing the Settings of Your Smart Body Analyzer .....     | 24 |
| Using Your Smart Body Analyzer .....                        | 32 |
| Tracking Your Weight.....                                   | 32 |
| Tracking Your Heart Rate .....                              | 38 |
| Tracking the Air Quality of the Room .....                  | 39 |
| Checking the Weather .....                                  | 40 |
| Linking Your Account to Partner Apps.....                   | 42 |
| Linking Your Account to MyFitnessPal.....                   | 42 |
| Syncing Your Data.....                                      | 44 |

|  |    |
|--|----|
| Dissociating Your Smart Body Analyzer .....                  | 45 |
| Performing a Factory Reset of Your Smart Body Analyzer ..... | 47 |
| Cleaning and Maintenance .....                               | 48 |
| Cleaning Your Smart Body Analyzer .....                      | 48 |
| Changing the Batteries.....                                  | 48 |
| Installing the Carpet Feet.....                              | 49 |
| Updating Your Smart Body Analyzer .....                      | 50 |
| Technology Description .....                                 | 52 |
| Weight .....   | 52 |
| Body Mass Index.....   | 52 |
| Fat Mass .....   | 52 |
| Heart Rate.....  | 52 |
| CO2 Level.....   | 52 |
| Temperature.....   | 52 |
| Specifications.....  | 53 |
| Document Release Overview.....                               | 55 |
| Warranty.....  | 56 |
| Regulatory Statements .....                                  | 57 |

# Minimum Requirements

---

## Internet Access

Access to the Internet is required to:

- Download the Withings Health Mate app,
- Set up your Smart Body Analyzer,
- Upgrade the firmware.

For more details, refer to [“Specifications” on page 53](#).

We recommend using the app on a device connected to the Internet to enjoy all features.

## Smartphone or Device

An iOS or Android device (with operational Bluetooth and Wi-Fi or 3G/4G) is required to:

- Set up your Smart Body Analyzer,
- Retrieve data from your Smart Body Analyzer,
- Access specific functions of your Smart Body Analyzer.

Bluetooth Low Energy (BLE) compatibility is recommended to install your Smart Body Analyzer.

For more details, refer to [“Specifications” on page 53](#).

## OS Version

On iOS, you need iOS 8 or above to install and run the Withings Health Mate App.

On Android, you need version 4.3 or above to install and run the Withings Health Mate App.

## Withings Health Mate App Version

We recommend that you use the latest available version of the Withings Health Mate app to have all the latest features available.

# Smart Body Analyzer Description

---

## Overview

The Smart Body Analyzer allows you to easily track your weight and monitor your progress. Not only does it let you know how much you weigh, it also calculates your Body Mass Index (BMI) to give you a better idea of where you stand as far as weight-related risks are concerned. Additionally, it calculates your fat mass by bioelectric impedance to inform you about your body composition.

Of course that's not all your Smart Body Analyzer does. It measures your heart rate, and detects the temperature and the CO2 level of the room (which you can easily see by pressing the central button of the scale). If you activate the Weather screen, you also get your daily weather report everytime you weigh in.

Because the Smart Body Analyzer is a connected scale, its true potential is achieved when you use it along with the Withings Health Mate app. Beside allowing you to install your scale, the Withings Health Mate app allows you to customize its display, to set a weight goal, and to check the entire history of your weight data.

Thanks to its in-app activity tracking feature and the numerous partner apps you can connect it to, the Withings Health Mate app helps you reach your weight goal faster by helping you track your activity and check your calorie balance.

## Box Contents

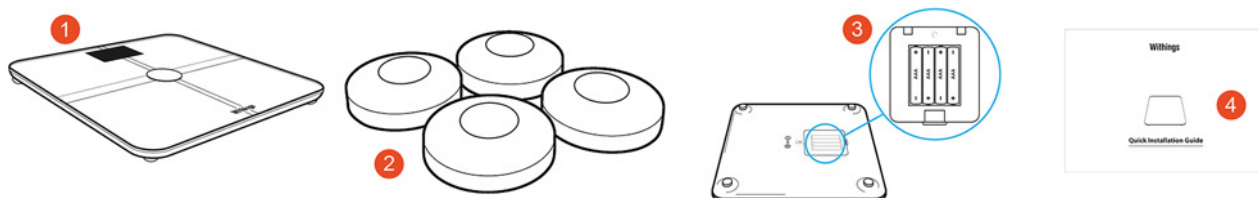

(1) Smart Body Analyzer    (2) Carpet feet  
(4) Quick Start Guide

(3) Batteries (inserted)

## Product Description

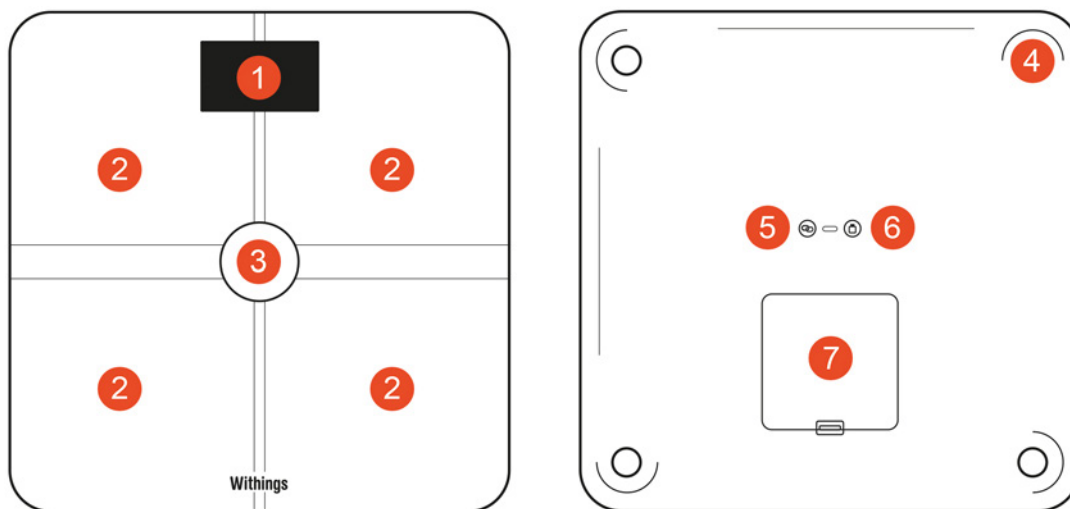

(1) Display

(2) Electrodes

(3) Air quality button

(4) Feet

(5) Pairing button

(6) Units button

(7) Battery compartment

## Scales Screens Description

You can select a number of screens to be displayed on your Smart Body Analyzer:

- Weight: Displays your weight. This screen cannot be disabled.
- Fat Mass: Displays your percentage of fat mass.
- Weather<sup>1</sup>: Displays the weather for the day.
- Heart Rate: Displays your heart rate.
- Air Quality: Displays the temperature of the room as well as the level of CO2.
- Weight Trend: Displays a graph with your last 8 weight measurements.
- Steps<sup>1,2</sup>: Displays the number of steps you did the previous day.
- NikeFuel<sup>3</sup>: Displays the amount of NikeFuel you earned the previous day.

You can disable or change the order of these screens as you like after you install your Smart Body Analyzer. Otherwise, they will appear in the default order. Refer to [“Changing the screen order” on page 25](#) for more information.

<sup>1</sup> This screen can only be used if you set up your Smart Body Analyzer in Wi-Fi

<sup>2</sup> You either need to own a Withings tracker, or to use the in-app tracking of the Withings Health Mate app to display your number of steps on this screen. If you don't have a Withings tracker, tap the Activity widget at the top of your Timeline in the Withings Health Mate app and tap **Activate now**. Your mobile device will then start tracking your steps.

<sup>3</sup> You need to have a Nike+ account to see your number of NikeFuels on this screen.



# Setting Up the Smart Body Analyzer

---

## Installing the Withings Health Mate App

If the Withings Health Mate app is not already installed on your device, perform the following steps:

1. Type [go.withings.com](http://go.withings.com) in your device's web browser.
2. Tap **Download on the App Store** and then **GET**.
3. Tap **Android App on Google play** and then **INSTALL**.  
The installation process starts.

# Installing your Smart Body Analyzer

## Overview

Installing your Smart Body Analyzer in Wi-Fi gives you access to all the features and screens available. Installing your Smart Body Analyzer in Bluetooth limits the features and screens available. For example, you can't use the Weather screen and the Steps screen, as they require access to the Internet.

You can change the configuration of your Smart Body Analyzer anytime you want. Refer to [“Changing the Configuration of Your Smart Body Analyzer” on page 21](#) for more information.

Note that once you've installed your Smart Body Analyzer on your account, all the users of the account can use it. You are also free to install it on various account. There is, however, a limit of eight users per scale at the moment.

## Installing your Smart Body Analyzer without an existing account

1. Pull the tab out of the battery compartment if it's the first time you install your Smart Body Analyzer.

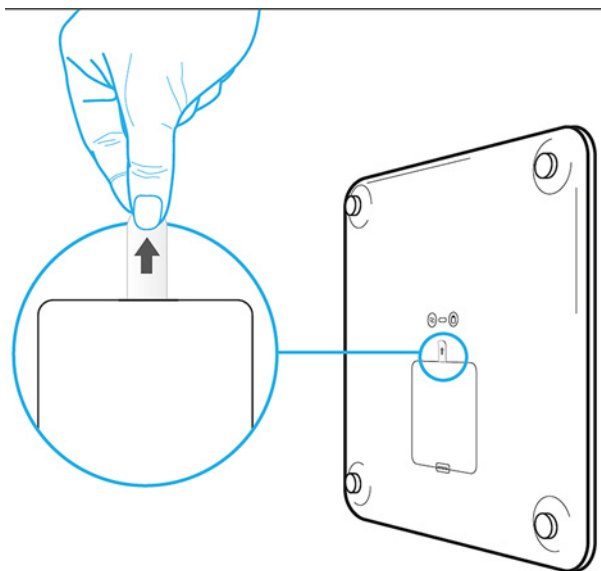

2. Open the Withings Health Mate app.

3. Tap **Join Withings**.



4. Tap **I'm setting up my device**.

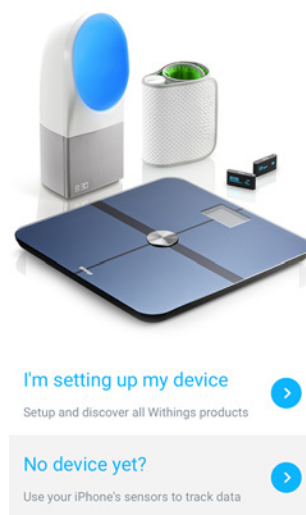

5. Tap **Smart Body Analyzer**.



6. Tap **Install now**.



7. Press the pairing button at the back of the scale for two seconds and tap **Next**.

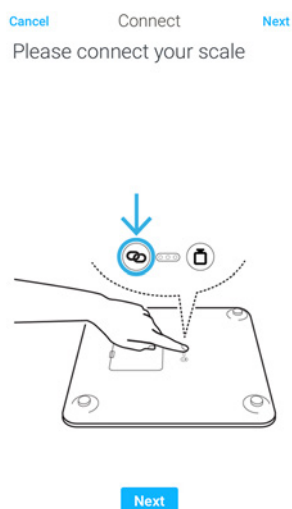

8. Tap the Smart Body Analyzer you want to install.

If your Smart Body Analyzer is not displayed in the list, go to the Bluetooth settings of your device and pair it from there. It should now appear in the Withings Health Mate app.

9. Tap **Next**.



10. Enter your email address, password, and then confirm your password. Tap **Next**.

11. Enter your first name, surname (last name) and birthday. Tap **Next**.

12. Select your gender and enter your current height and weight. Tap **Create**.

13. To install your scale in Wi-Fi, perform the following steps:

- a. Tap **Quick setup** to use the same Wi-Fi network as your mobile device or **Setup another network** to use another one.

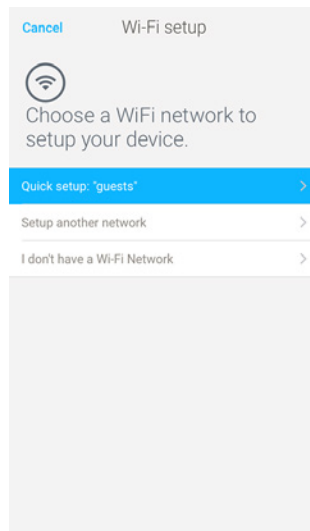

b. Tap **Allow**.

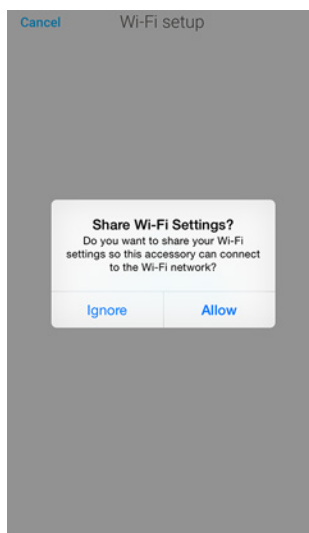

You will need to update the Wi-Fi configuration if you change the network name or password. Refer to [“Changing the Configuration of Your Smart Body Analyzer”](#) on page 21 for more information.

14. To install your scale in Bluetooth, tap **I don't have a Wi-Fi Network**.

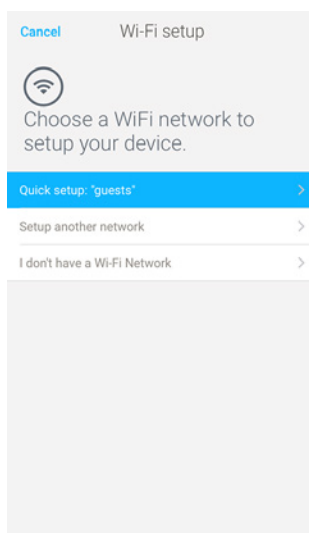

15. Tap **Close**.



The Withings Health Mate now prompts you to select your target weight. Tap Cancel if you don't want to set a weight goal. You can set one later on if you change your mind. Refer to [“Changing Your Weight Goal” on page 33](#) for more information.

### Installing your Smart Body Analyzer with an existing account

1. Pull the tab out of the battery compartment if it's the first time you install your Smart Body Analyzer.

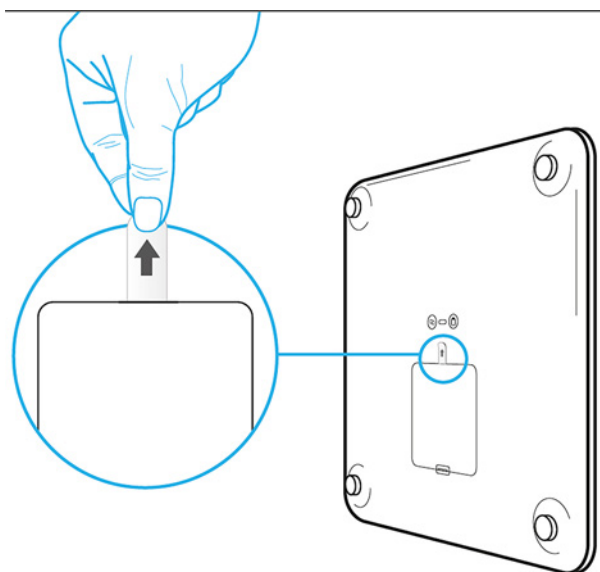

2. Open the Withings Health Mate app.
3. Go to **My devices**.

4. Tap **+**.

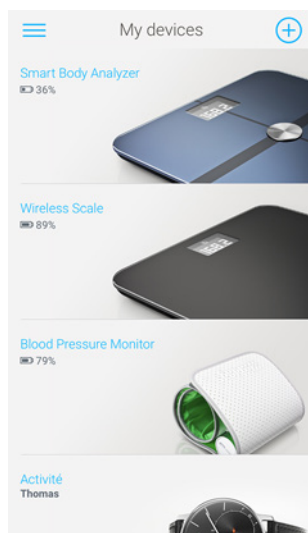

5. Tap **Smart Body Analyzer**.



6. Tap **Install now**.





7. Press the pairing button at the back of the scale for two seconds and tap **Next**.

Cancel      Connect      Next  
Please connect your scale

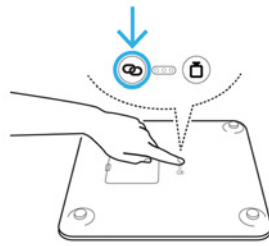

Next

8. Tap the Smart Body Analyzer you want to install.  
If your Smart Body Analyzer is not displayed in the list, go to the Bluetooth settings of your device and pair it from there. It should now appear in the Withings Health Mate app.
9. Tap **Next**.

Cancel      Connect      Next  
✔  
Scale detected



Next

10. To install your scale in Wi-Fi, perform the following steps:

a. Tap **Quick setup** to use the same Wi-Fi network as your mobile device or **Setup another network** to use another one.

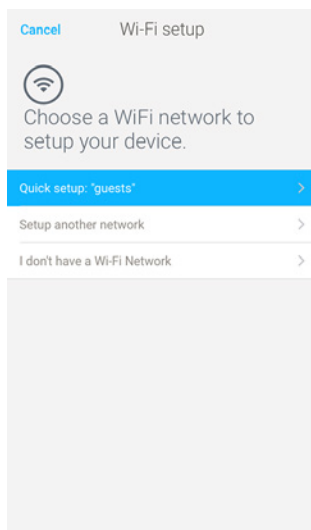

b. Tap **Allow**.

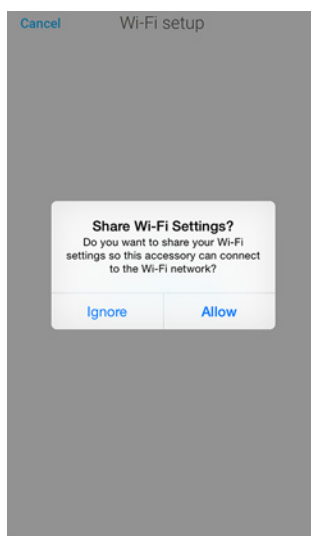

You will need to update the Wi-Fi configuration if you change the network name or password. Refer to [“Changing the Configuration of Your Smart Body Analyzer”](#) on page 21 for more information.

11. To install your scale in Bluetooth, tap **I don't have a Wi-Fi Network**.

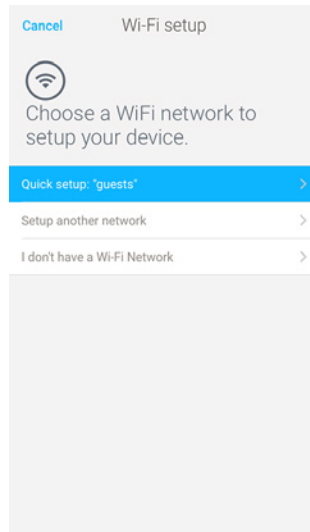

12. Tap **Close**.

The Withings Health Mate now prompts you to select your target weight.

## Selecting your weight goal

To select your weight goal, perform the following steps:

1. Tap and slide up or down to select your target weight.

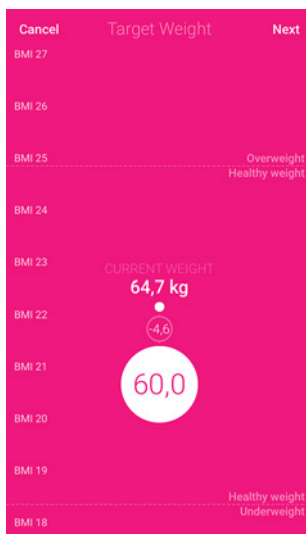

2. Tap **Next**.
3. Tap and slide up or down to select the pace at which you want to achieve your weight goal.



4. Tap **OK**.

# Customizing Your Smart Body Analyzer

## Changing the Configuration of Your Smart Body Analyzer

You may need to change the configuration of your Smart Body Analyzer:

- If you want to use a different Wi-Fi network,
- If you want to switch to a Wi-Fi configuration,
- If you want to switch to a Bluetooth configuration.

To change your configuration, perform the following steps:

1. Open the Withings Health Mate app.
2. Go to **My devices**.
3. Tap **Smart Body Analyzer**.

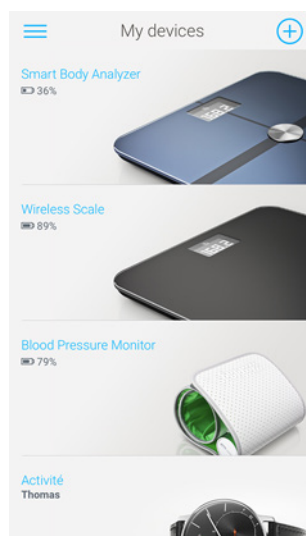

4. Tap **Wi-Fi Configuration**.

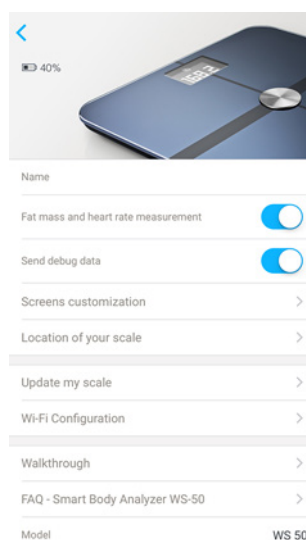

5. Press the pairing button at the back of the scale and tap **Next**.

Cancel      Connect      Next  
Please connect your scale

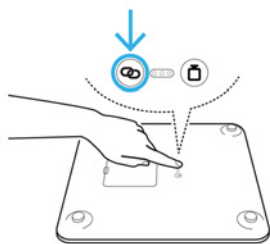

Next

6. Tap the Smart Body Analyzer you want to install.  
If your Smart Body Analyzer is not displayed in the list, go to the Bluetooth settings of your device and pair it from there. It should now appear in the Withings Health Mate app.

7. Tap **Next**.

Cancel      Connect      Next  
 Scale detected

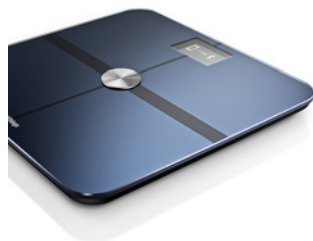

Next

8. To switch to a Wi-Fi configuration or to update the Wi-Fi network:

a. Tap **Quick setup** to use the same Wi-Fi network as your mobile device or **Setup another network** to use another one.

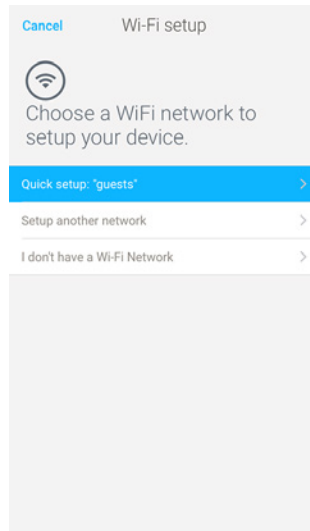

b. Tap **Allow**.

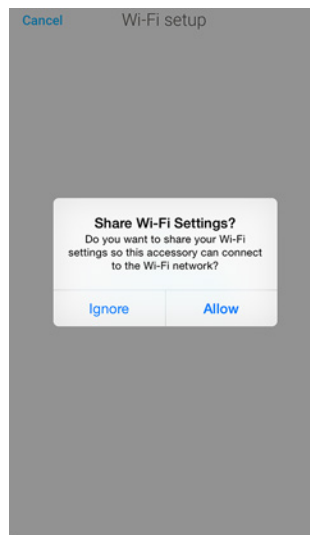

9. To switch to a Bluetooth configuration, tap **I don't have a Wi-Fi Network**.

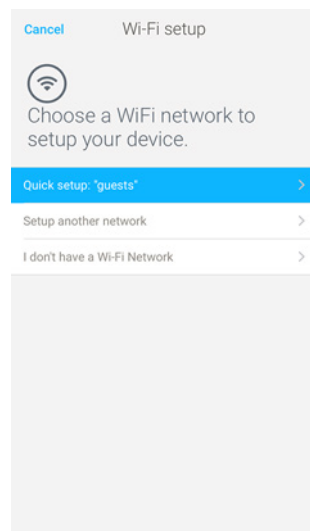

10. Tap **Close**.



## Changing the Settings of Your Smart Body Analyzer

### Changing the weight unit

You have the choice between three weight units: kilogram (kg), stone (stlb) and pound (lb). To change the units on your Smart Body Analyzer, perform the following steps:

1. Press and hold the unit button at the back of your Smart Body Analyzer for a few second.

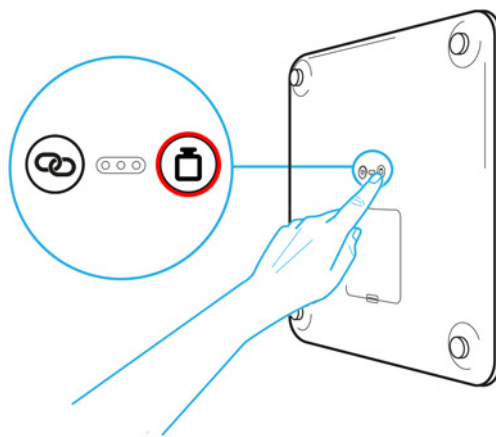

2. Press the unit button again to change the unit.  
Check the screen of your scale to see the unit change.  
The unit change is confirmed a few seconds after you stop pressing the button.



## Changing the temperature unit

While you can change the weight unit directly from your Smart Body Analyzer, the temperature unit (used in the Weather screen and in the Air Quality screen) can only be changed from the Withings Health Mate app. To do so, perform the following steps:

1. Open the Withings Health Mate app.
2. Go to **Settings**.
3. Tap **Units**.

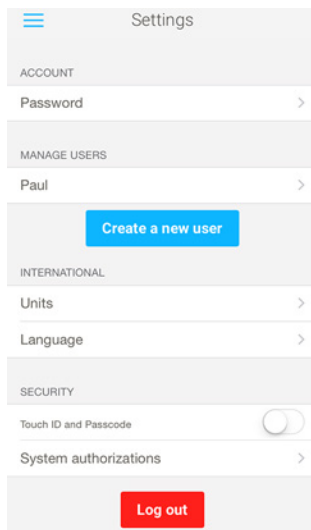

4. Select the temperature unit you want.

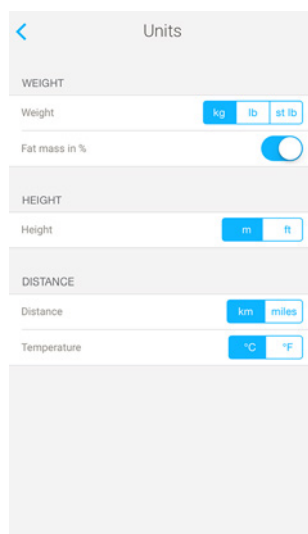

You can also change the weight unit from this screen but it will only affect the display in the Withings Health Mate app. The weight unit on the Smart Body Analyzer can only be changed from the scale itself.

5. Tap the back button to confirm.

## Changing the screen order

You can change the order of the screens of your Smart Body Analyzer, for example if you want to display the Weather screen first. To do so, perform the following steps:

1. Open the Withings Health Mate app.
2. Go to **My devices**.
3. Tap **Smart Body Analyzer**.



4. Tap **Screens customization**.

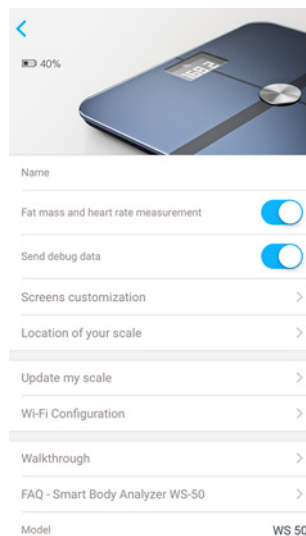

5. Tap the user profile for which you want to change the screen order.

6. Select the screens you want to display:

- Tap the blue circles on the left to hide a screen.
- Tap the empty circles on the left to display a screen.

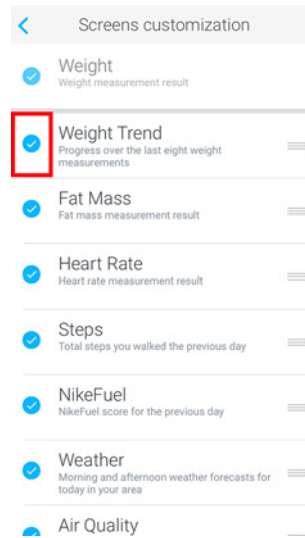

7. Tap and hold the icon on the right to drag a screen up or down.

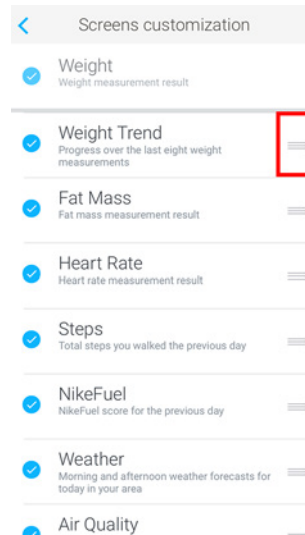

8. Tap the back button to confirm.

9. Weigh yourself once to synchronize your Smart Body Analyzer with your app and finalize the change.

The change will be effective for your next weigh-in.

## Changing the location of your scale

The location of your scale is used to provide you with the correct weather forecast if you have activated the Weather screen. It is based on your IP address but it is not always accurate. If the preset location of your scale happens to be incorrect, you are free to change it anytime you want. To do so, perform the following steps:

1. Open the Withings Health Mate app.
2. Go to **My devices**.
3. Tap **Smart Body Analyzer**.

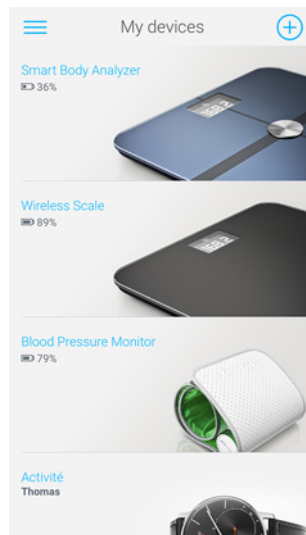

4. Tap **Location of your scale**.

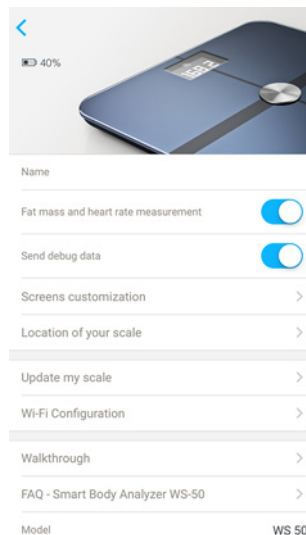

5. Enter the correct location of your scale and tap **OK**.

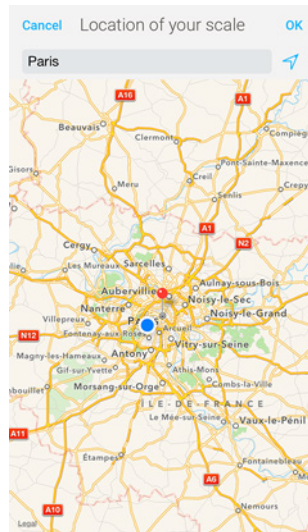

### Disabling fat mass and heart rate measurements

You can disable fat mass and heart rate measurement if you choose to. This is recommended for pregnant women and mandatory for anyone wearing a pacemaker.

To disable fat mass and heart rate measurements, perform the following steps:

1. Open the Withings Health Mate app.
2. Go to **My devices**.
3. Tap **Smart Body Analyzer**.

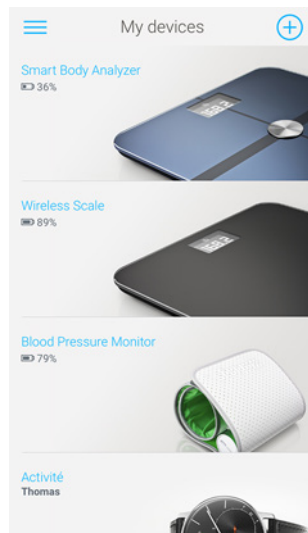

#### 4. Tap **Fat mass and heart rate measurement**.

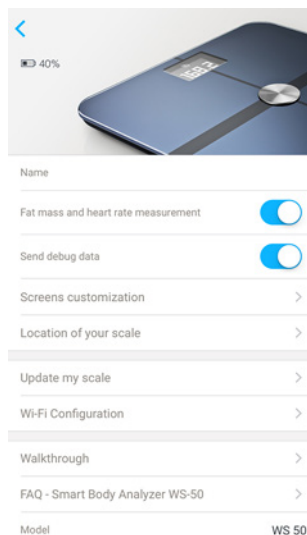

#### 5. Tap the back button to confirm.

### Using the Athlete mode

Athletes generally have a different body type which requires a specific fat mass calculation algorithm. If you work out more than 8 hours a week and have a resting heart rate below 60 bpm, you may need to use the Athlete mode. To do so, perform the following steps:

1. Open the Withings Health Mate app.
2. Go to **Profile**.
3. Tap User details.

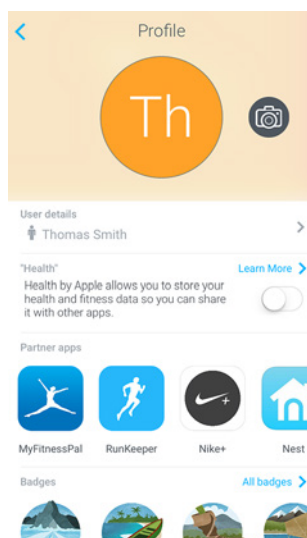

4. Tap Advanced settings.

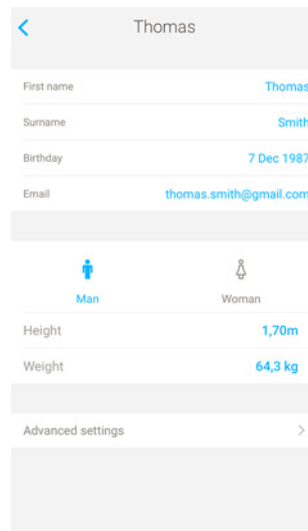

5. Tap Athlete.

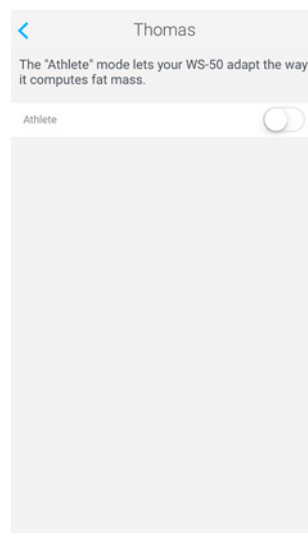

6. Tap the back button to confirm.

# Using Your Smart Body Analyzer

---

## Tracking Your Weight

### Overview

The Smart Body Analyzer allows you to track your weight and Body Mass Index (BMI).

It also lets you see how your weight trend changes over time. Besides your weight and BMI, it also allows you to track your fat mass which gives you a better idea of your level of fitness.

Make sure you follow the following recommendations to get accurate and representative weight measurements:

- Make sure you always weigh yourself around the same time to improve the consistency of your measurements.
- Wait five seconds before weighing yourself if you have just moved your scale.
- If your scale is on a carpet, make sure you're using the carpet feet. Refer to [“Installing the Carpet Feet” on page 49](#) for more information.

### Weighing Yourself

Thanks to the Position Control™ technology, getting an accurate weight measurement has never been easier. If your weight is not properly distributed on your Smart Body Analyzer, arrows are displayed on the scale to indicate in which direction you should lean to stabilize your weight.

If several users have a similar weight, the following screen can be displayed:

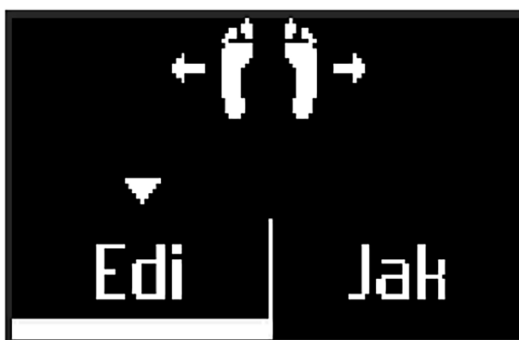

Simply lean left or right to select the correct name.

If you want to get fat mass and/or heart rate measurements as well, make sure that:

- Fat mass and heart rate measurements are enabled. Refer to [“Disabling fat mass and heart rate measurements” on page 29](#) for more information.
- The Fat Mass screen and/or the Heart Rate screen are enabled. Refer to [“Changing the screen order” on page 25](#) for more information.
- You step on the scale barefoot.



- You stay as still as possible during the measurement.
- You are recognized by your Smart Body Analyzer.

## Retrieving Your Weight Data

As soon as you weigh yourself, your weight is displayed on the display of your scale.

If you've activated the Weight Trend screen, you'll also see a graph showing your eight last measurements as well as the delta between the latest measurement and the previous one.

To see detailed graphs about your weight and see your full history, you have to check your data on the Withings Health Mate app.

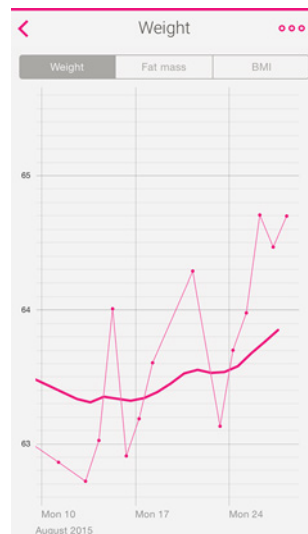

You can access your graphs:

- By tapping the Weight widget at the top of your Timeline.
- By tapping any weight measurement item in your Timeline.

Once you're viewing the weight graph, you can alternate between the tabs to view your weight graph, your fat mass graph and your BMI graph.

## Changing Your Weight Goal

To change your weight goal, perform the following steps:

1. Open the Withings Health Mate app.

2. Tap the right part of the Weight widget.

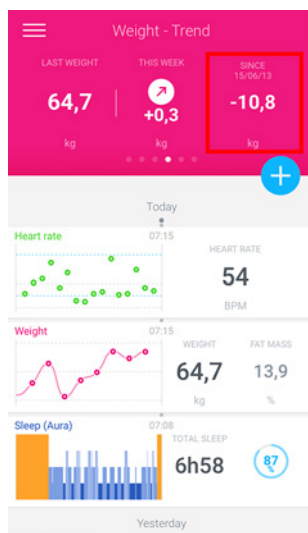

3. Tap and slide up or down to select your target weight.

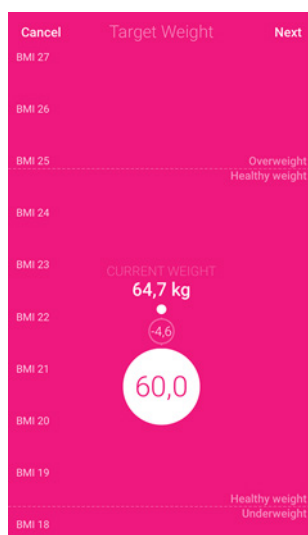

4. Tap **Next**.

5. Tap and slide up or down to select the pace at which you want to achieve your weight goal.

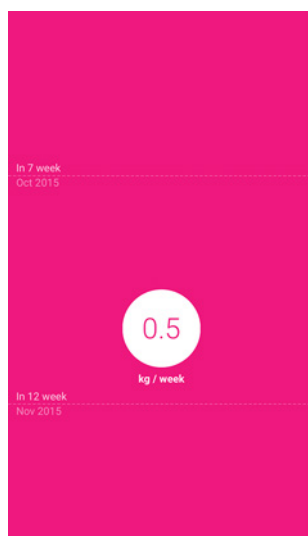

6. Tap **OK**.

## Retrieving unknown measurements

If your Smart Body Analyzer doesn't recognize you when you weigh in, your weight measurements will be listed as unknown measurements. To assign them to a user, perform the following steps:

1. Open the Withings Health Mate app.
2. Locate **Unknown measures** on the left menu.

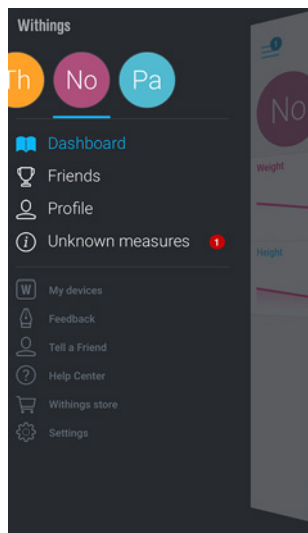

3. Tap the measurement.

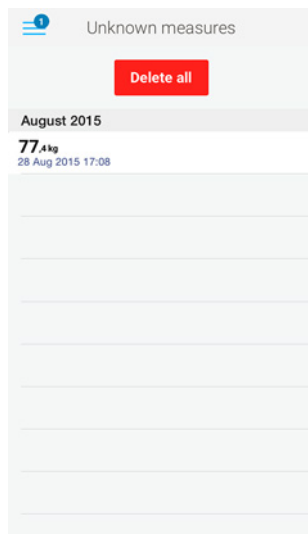

4. Tap the user you want to assign it to.

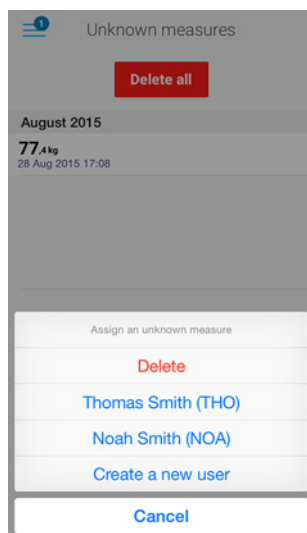

## Setting Reminders

The Withings Health Mate app allows you to set reminders to make sure you weigh yourself regularly. To do so, perform the following steps:

1. Open the Withings Health Mate app.
2. Tap **Reminders**.
3. Tap **Discover now**.



4. Select the type of reminder you want to set.

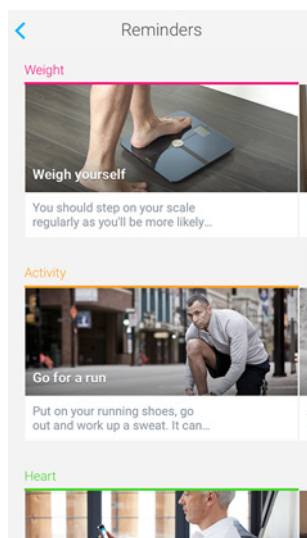

5. Select the time and recurrence of the reminder.

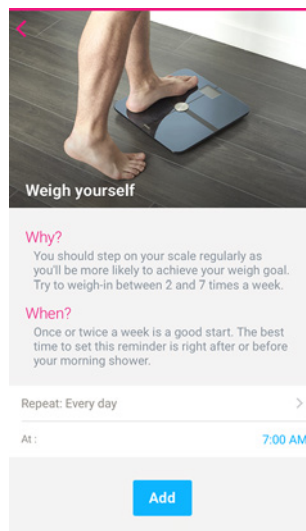

6. Tap **Add**.

## Tracking Your Heart Rate

### Overview

**This product is not a medical device and should not be used to diagnose, treat, cure, or prevent any medical conditions.**

The Smart Body Analyzer allows you to track your heart rate and lets you see how it changes over time.

If you want to get heart rate measurements, make sure that:

- Fat mass and heart rate measurements are enabled. Refer to [“Disabling fat mass and heart rate measurements” on page 29](#) for more information.
- The Heart Rate screen is enabled. Refer to [“Changing the screen order” on page 25](#) for more information.
- You step on the scale barefoot.
- You stay as still as possible during the measurement.

### Retrieving Your Heart Rate Measurements

As soon as your heart rate is measured, it is displayed on the display of your scale.

To see detailed graphs about your heart rate and see your full history, you have to check your data on the Withings Health Mate app.

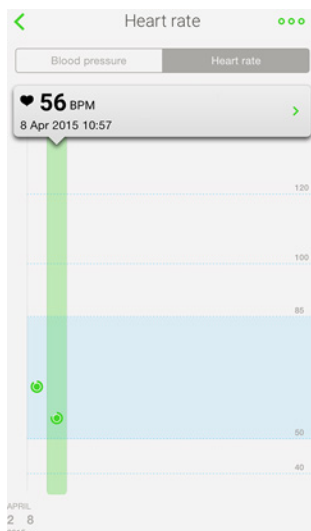

You can access your graphs by tapping any heart rate measurement item in your Timeline.

## Tracking the Air Quality of the Room

### Overview

The Smart Body Analyzer allows you to track the temperature and the air quality of the room it's located in. It also lets you see how the air quality changes over time so that you know when you need to open a window, for example.

The temperature is expressed in degrees Celsius or degrees Fahrenheit depending on the unit you've chosen. Refer to ["Changing the temperature unit" on page 24](#) for more information.

The CO2 level is expressed in parts per million (ppm). It gives a good indication of the air quality and the ventilation of the room.

- 450 - 1,000 ppm: Good
- 1,000 - 2,000 ppm: Medium
- 2,000 - 3,000 ppm: Bad
- > 3,000 ppm: Very bad

### Retrieving Your Air Quality Measurements

You can view the temperature of the room and the CO2 level at any moment by pressing the central button of your Smart Body Analyzer.

To see detailed graphs about the air quality of the room and see the full history, you have to check your data on the Withings Health Mate app.

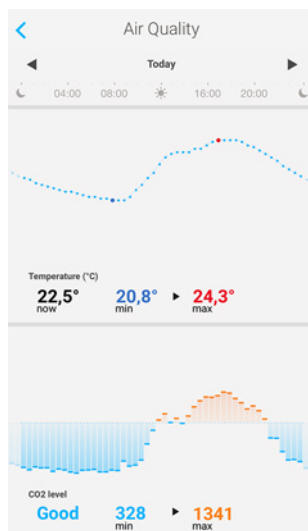

You can access them by tapping the Air Quality widget at the top of your Timeline.



## Checking the Weather

### Overview

You can check the local weather forecast for the day directly on your Smart Body Analyzer if the following conditions are met:

- Your Smart Body Analyzer is set up in Wi-Fi. Refer to [“Changing the Configuration of Your Smart Body Analyzer”](#) on page 21 for more information on how to switch to a Wi-Fi configuration.
- The Weather screen is enabled. Refer to [“Changing the screen order”](#) on page 25 for more information.



## Retrieving Weather Information

All you have to do to retrieve weather information on your Smart Body Analyzer is to step on the scale and wait for the Weather screen to be displayed.

The Weather screen provides you with information about the average weather and temperature for the morning (between 6:00 AM and 12:00 PM) and for the afternoon (between 12:00 PM and 9:00 PM).



If you weigh yourself in the morning, the data of the day is displayed. If you weigh after 7:00 PM, the data of the next day is displayed.

# Linking Your Account to Partner Apps

---

## Linking Your Account to MyFitnessPal

### Overview

When you monitor your weight, it can also be useful to monitor your calorie intake with apps such as MyFitnessPal to help you reach your weight goal.

Once you link both accounts, your Withings account will be able to retrieve your daily calorie intake from MyFitnessPal. You can then check the MyFitnessPal widget from your Dashboard to see your calorie balance.

MyFitnessPal can also retrieve information from your Withings account: your weight and your calorie outtake.

Your calorie outtake is based on any activity data coming from a Withings activity tracker or the in-app tracking feature of the Withings Health Mate app. Note that tracking your activity can be a great way to help you achieve your weight goal.

### Connecting to MyFitnessPal

To connect your Withings account to your MyFitnessPal account, perform the following steps:

1. Open the Withings Health Mate app.
2. Tap **Profile**.
3. Tap **MyFitnessPal**.



4. Tap **Next**.

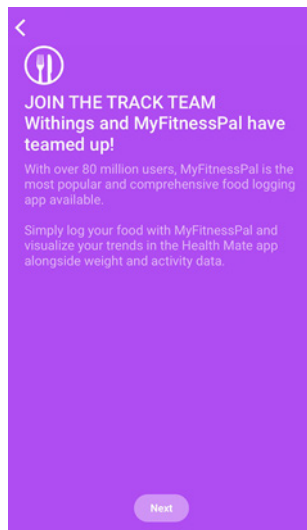

5. Tap **I accept**.

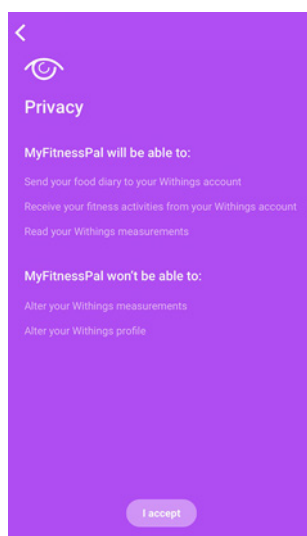

6. Tap **Back to the app**.

7. Tap **Continue**.

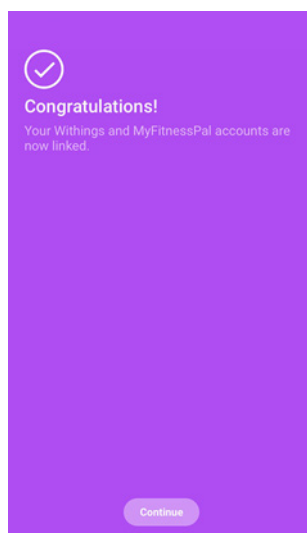

You can unlink your MyFitnessPal account and your Withings account anytime you want from your Profile.

# Syncing Your Data

---

Data from your Smart Body Analyzer is automatically synced, without any action required on your part. Your weight data is synced with the Withings Health Mate app within a few minutes after you weigh in. Your heart rate and air quality data are also synced at this time.

If you've set up your Smart Body Analyzer in Wi-Fi, your air quality data is also synced:

- 14 hours after your last weigh-in and then every 14 hours (default behavior)
- Once a night (if the Steps screen or the NikeFuel screen are activated)

If you've set up your Smart Body Analyzer in Bluetooth, your air quality data is only synced when you weigh in. For this reason, we advise that you weigh in regularly. If you don't, large volumes of air quality data will be waiting to be synced and it may cause difficulties when you try to retrieve the rest of your data.

# Dissociating Your Smart Body Analyzer

**All data that wasn't synced before dissociating your Smart Body Analyzer will be lost permanently.**

Dissociating your Smart Body Analyzer allows you to remove it from your account.

**Dissociating your Smart Body Analyzer will not remove any of the data that was synced from the Withings Health Mate app.**

To dissociate your Smart Body Analyzer, perform the following steps:

1. Open the Withings Health Mate app.
2. Go to **My devices**.
3. Tap **Smart Body Analyzer**.

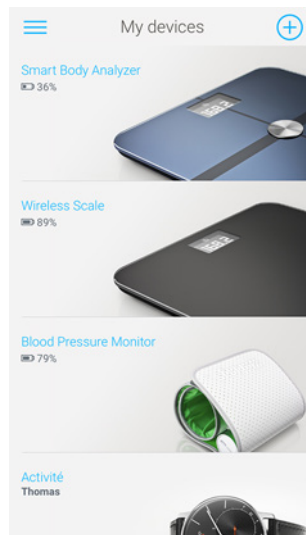

4. Tap **Dissociate this product**.

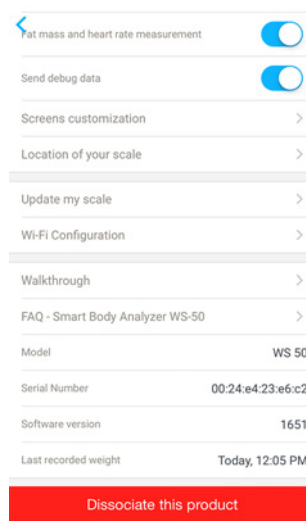

5. Tap **Remove from my account**.

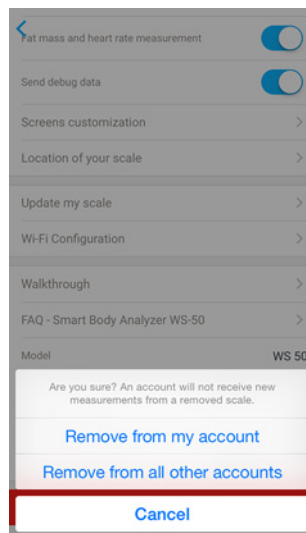

6. Perform a factory reset of your Smart Body Analyzer. Refer to [“Performing a Factory Reset of Your Smart Body Analyzer”](#) on page 47 for more information.

# Performing a Factory Reset of Your Smart Body Analyzer

---

**All data that wasn't synced before factory resetting your Smart Body Analyzer will be lost permanently.**

Factory resetting your Smart Body Analyzer allows you to delete the data stored on it. Factory resetting completes the dissociation process.

**Factory resetting your Smart Body Analyzer will not remove any of the data from the Withings Health Mate app.**

1. Go to the Bluetooth settings of your device and “forget” your Smart Body Analyzer. from the list of Bluetooth devices.
2. Remove one of the batteries for ten seconds.
3. Put the battery back.
4. When “Hello” appears on the display of your scale, press and hold the two buttons at the back of the scale for 20 seconds until “Factory” appears.

At this time, you can start the installation process for the Smart Body Analyzer. Refer to [“Setting Up the Smart Body Analyzer” on page 9](#) for more information.

# Cleaning and Maintenance

---

## Cleaning Your Smart Body Analyzer

You can clean your Smart Body Analyzer using a cloth dampened with water. If water is not enough to clean it, you can also use crystal vinegar.

**The use of any detergents or cleaners may cause irreversible damage to the coating that protects the electrodes used to measure your fat mass and heart rate.**

## Changing the Batteries

Your Smart Body Analyzer uses four standard AAA batteries and has an autonomy of 8 months. To check the battery level of your Smart Body Analyzer; perform the following steps:

1. Open the Withings Health Mate app.
2. Go to **My devices**.
3. Tap **Smart Body Analyzer**.

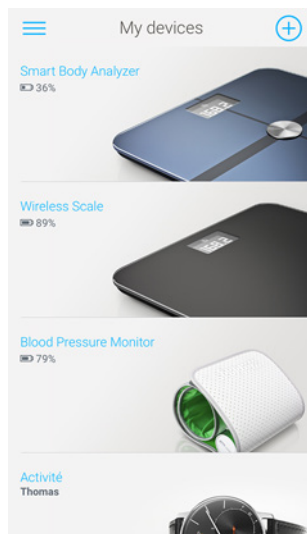



4. Check the battery level displayed at the top.

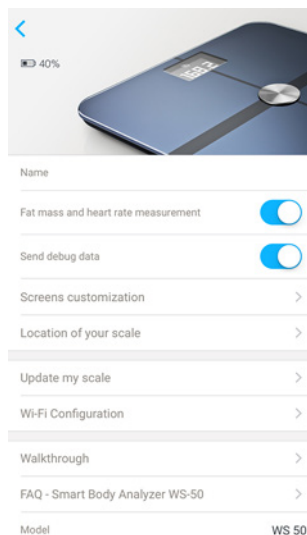

If the battery level is below 20% and you're having syncing issues, we advise that you change the batteries.

## Installing the Carpet Feet

If you are using your Smart Body Analyzer on a carpet, we recommend that you use the carpet feet included with your scale. To do so, perform the following steps:

1. Remove the tab below each carpet foot.

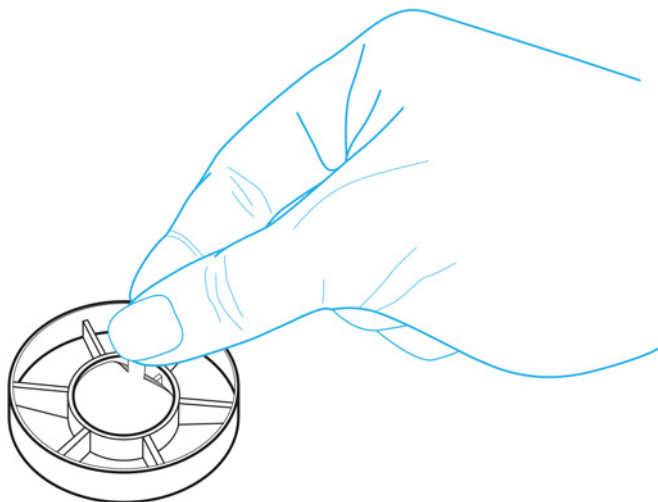

2. Stick each carpet foot on the Smart Body Analyzer feet.

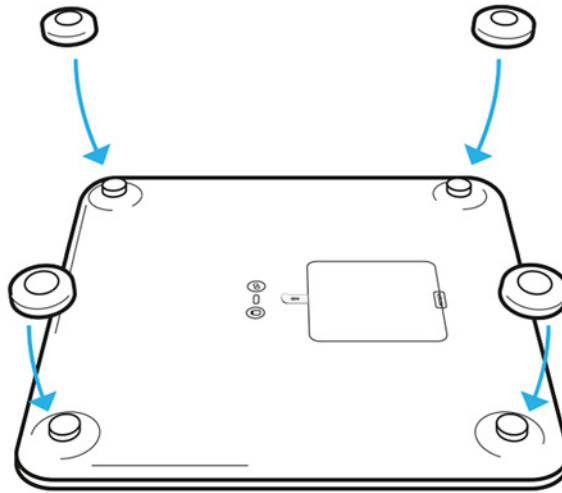

## Updating Your Smart Body Analyzer

We regularly offer new firmware so that you can benefit from the latest features we add to our products. When new firmware is available, it is automatically installed without any prompt from the Withings Health Mate app.

However, you can check if updates are available and force their installation whenever you want. To do so, perform the following steps:

1. In the Withings Health Mate app, go to **My devices**.
2. Tap **Smart Body Analyzer**.



3. Tap **Update my scale**.

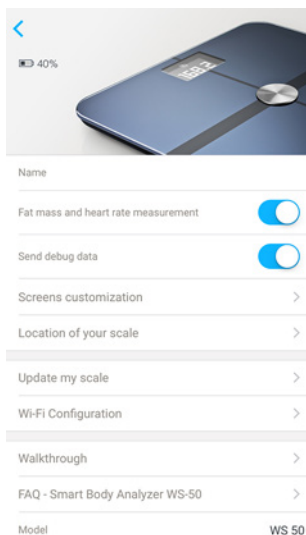

4. Press the pairing button at the back of the scale and tap **Next**.

Cancel    Connect    **Next**  
Please connect your scale

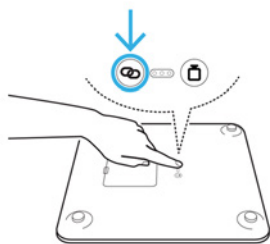

**Next**

5. Tap the Smart Body Analyzer you want to update.

6. Tap **Upgrade**.

7. Tap **Close** when the upgrade is complete.

**Note:** You can check which firmware version your Smart Body Analyzer uses in **My devices > Smart Body Analyzer**.

# Technology Description

---

## Weight

Your weight is measured thanks to four weight sensors placed below the surface of your Smart Body Analyzer.

## Body Mass Index

The Body Mass Index (BMI) is calculated based on your weight and height. It is an international standard adopted by the World Health Organization which helps evaluate the health risks linked to abnormal weight.

Generally speaking, a BMI between 18 and 25 is considered as “normal”, meaning that weight-related risks to your health are low. Please note, however, that BMI is only an indicator, and that it doesn't take into account a person's morphology.

## Fat Mass

Your fat mass percentage is measured by bioelectrical impedance analysis thanks to electrodes placed below the surface of your Smart Body Analyzer. These electrodes send a small current that goes through your body, and then analyse the way your body reacts to measure your fat mas percentage.

## Heart Rate

Your Smart Body Analyzer uses patent-pending heart rate measurement technology to measure your heart rate while you weigh in.

## CO2 Level

Your Smart Body Analyzer measures the level of CO2 in the room thanks to a CO2 sensor.

## Temperature

Your Smart Body Analyzer measures the temperature of the room thanks to a temperature sensor.

# Specifications

---

## Smart Body Analyzer

- Length: 325 mm (12.8")
- Width: 325 mm (12.8")
- Depth: 23 mm (0.90")
- Weight: 2.1 kg (4.6 lbs)
- Weight range: 5 kg - 180 kg (9 lbs - 396 lbs)
- Weight units: kg, lb, stlb
- Precision: 100 g (3.5 oz)

## Display

- 6.1 cm x 4.1 cm (2.4" x 1.6")
- 128 x 64 pixels
- Backlighting

## Connectivity

- Wi-Fi 802.11 b/g/n (2,4 GHz only)
- Bluetooth / Bluetooth Low Energy (Bluetooth Smart Ready)

## Sensors

- 4 weight sensors
- Position Control™ technology
- Temperature sensor
- Air quality sensor

## Metrics

- Weight
- Body Mass Index (BMI)
- Fat mass (standard and athlete mode)
- Heart rate
- CO2 level of the room
- Temperature of the room

## Batteries

- 8 months autonomy
- 4 AAA batteries

## Features

- Automatic user recognition
- Weather forecast

## Compatible Devices

- iPhone 4s (or higher)
- iPod Touch 4th Gen (or higher)
- iPad 2nd Gen (or higher)
- Bluetooth Low Energy compatible Android device

## Compatible OS

- iOS 8 (or higher)
- Android 4.3 (or higher)

# Document Release Overview

---

| Release date |      | Modifications |
|--------------|------|---------------|
| May 2016     | v1.0 | First release |

**The screenshots in this manual are used for explanatory purposes. Your actual screens may differ from the screenshots in this manual.**

# Warranty

---

## Withings One (1) Year Limited Warranty - Smart Body Analyzer

Withings warrants the Withings branded hardware product (“Smart Body Analyzer”) against defects in materials and workmanship when used normally in accordance with Withings’ published guidelines for a period of ONE (1) YEAR from the date of original retail purchase by the end-user purchaser (“Warranty Period”). Withings’ published guidelines include but are not limited to information contained in technical specifications, safety instructions, or quick start guide. Withings does not warrant that the operation of the Smart Body Analyzer will be uninterrupted or error-free. Withings is not responsible for damage arising from failure to follow instructions relating to the Smart Body Analyzer’s use.

### **The warranty does not extend to:**

- Any damage to the device resulting from abnormal or abusive use, negligence or lack of care, or accidental damage (such as dents).
- Indirect damages of any kind.



# Regulatory Statements

---

FCC ID: XNA-WS-50

This device complies with Part 15 of the FCC Rules.

Operation is subject to the following two conditions: (1) This device may not cause harmful interference, and (2) This device must accept any interference received, including interference that may cause undesired operation.

This device complies with the R&TTE Directive. A copy of the EU Declaration of Conformity is available online at <https://www.withings.com/fr/en/compliance>.